

ACS Series

Common Terminal Block

■ Features

- Compact common terminal blocks with 7mm terminal pitch
- No jumper bars required due to built-in common PCB
- For use as power supply expansion terminals
- Compact, space-saving design
- 2 mounting methods (DIN rail, screw mount)

 Please read "Caution for your safety" in operation manual before using.



■ Model

Model	Item	Terminal type	No. of terminals	Common type
ACS-20L	Common terminal block	Screw	20 EA	Left-Right common
ACS-20T				Up-Down common
ACS-40L			40 EA	Left-Right common
ACS-40T				Up-Down common
ACS-50L			50 EA	Left-Right common
ACS-50T				Up-Down common

■ Terminal Specifications

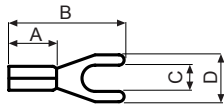

< Spade terminal >

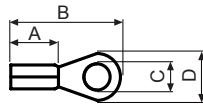

< Ring terminal >

(unit: mm)

	A	B	C	D	Applicable wire
Spade terminal	Min. 4.1	Min. 16.0	Min. 3.0	Max. 5.9	AWG 22-16
Ring terminal	Min. 4.1	Min. 16.0	Min. 3.0	Max. 5.9	(0.30 to 1.25mm ²)

※ Please use UL certified terminals.

■ Specifications

Model	ACS-20L	ACS-20T	ACS-40L	ACS-40T	ACS-50L	ACS-50T
Power supply	Max. 125VDC, 125VAC 50/60Hz					
Rated current	Max. 10A					
Common type	Left +COM, Right -COM	Up +COM, Down -COM	Left +COM, Right -COM	Up +COM, Down -COM	Left +COM, Right -COM	Up +COM, Down -COM
No. of terminals	20 EA		40 EA		50 EA	
Terminal pitch	7.0mm					
Applicable wire	AWG22-16 (0.30 to 1.25mm ²)					
Insulation resistance	Min. 1,000MΩ (at 500VDC megger)					
Dielectric strength	600VAC 50/60Hz for 1 min.					
Vibration	0.75mm amplitude at frequency of 10 to 55 Hz (for 1 min.) in each X, Y, Z direction for 2 hours					
Shock	150m/s ² (15G) in each X, Y, Z direction for 3 times					
Environment	Ambient temperature	-15 to 55°C, storage: -25 to 65°C				
	Ambient humidity	35 to 85%RH, storage: 35 to 85%RH				
Material	CASE: MPPO, TERMINAL PIN: Brass					
Tightening torque	5.1 to 6.1 kgf·cm (0.5 to 0.6 N·m)					
Approval						
Weight ^{※1}	Approx. 92g (approx. 61g)		Approx. 157g (approx. 115g)		Approx. 189g (approx. 141g)	

※1: The weight includes packaging. The weight in parentheses is for unit only.

※Environment resistance is rated at no freezing or condensation.

Common Terminal Block

Dimensions

ACS-20L(T)

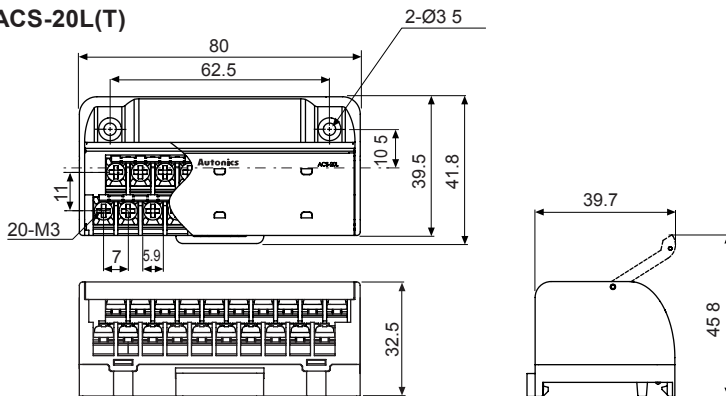

(unit: mm)

ACS-40L(T) / ACS-50L(T)

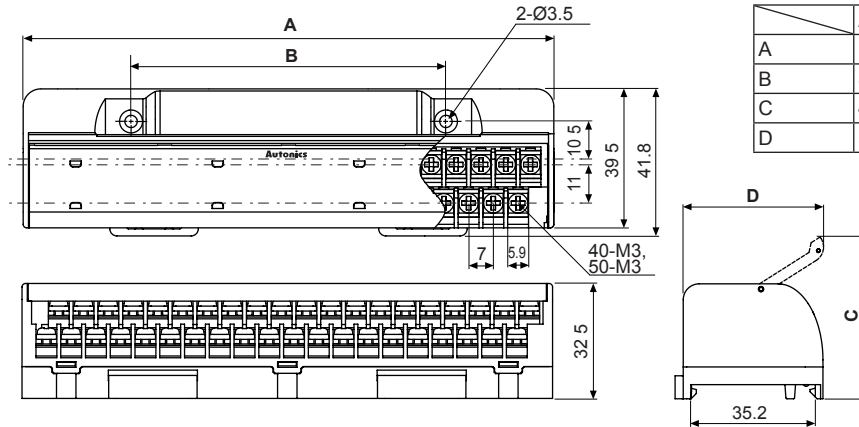

Connections

ACS-20L

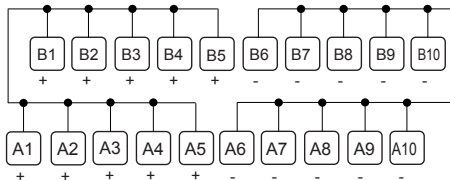

ACS-20T

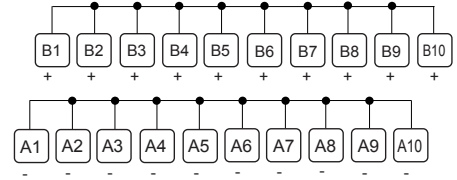

ACS-40L

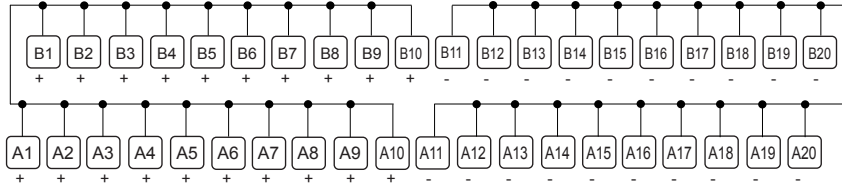

ACS-50L

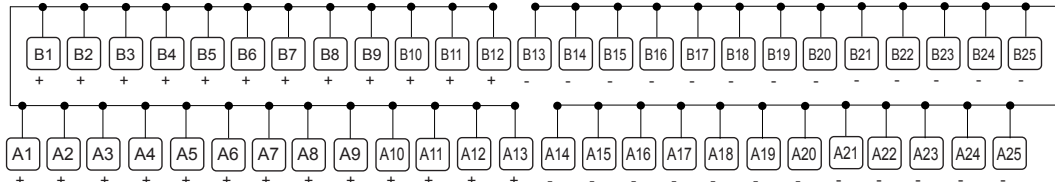

ACS-40T / ACS-50T

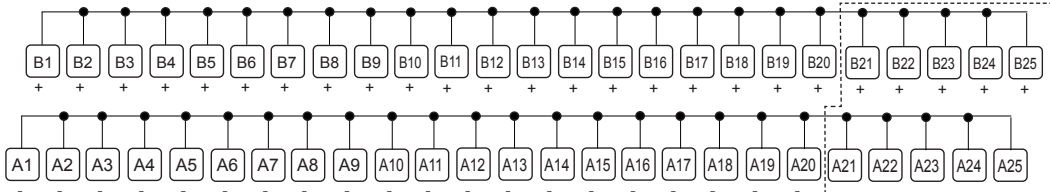

※Dot line part is only for ACS-50T model.

I/O Terminal Blocks

- AFS(Interface Terminal Block)
- AFJ/AFR(Interface Terminal Block)
- ACS(Common Terminal Block)
- AFE(Sensor Connector Terminal Block)
- ABS(Relay Terminal Block)
- ABL(Relay Terminal Block)
- Power Relay

I/O Cables

- MITSUBISHI
- LSIS
- Autonics
- RS Automation
- YOKOGAWA
- FUJI
- KDT
- OMRON
- TELEMECANIQUE
- For SERVO
- Open Type Cables
- Cable Appearance

Remote I/O

- ARD(DeviceNet Digital Standard Terminal Type)
- ARD(DeviceNet Digital Sensor Connector Type)
- ARD(DeviceNet Analog Standard Terminal Type)
- ARM(Modbus Digital Sensor Connector Type)

Others

- Sensor Connectors
- Sockets
- Sensor Distribution Boxes
- Valve Plugs
- Thumbwheel Switches

■ Installation

◎ Mounting and Removal at DIN rail

● Mounting

- 1) Pull the rail lock towards direction ①.
- 2) Attach the DIN rail connection hook onto the DIN rail.
- 3) Push the unit towards direction ②, then push the rail lock in to lock into position.

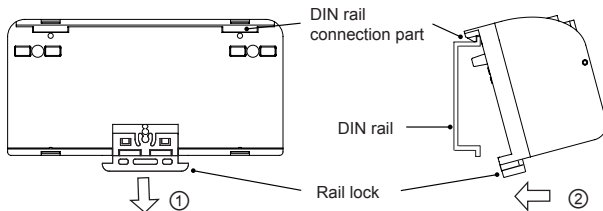

● Removal

- 1) Insert a screwdriver into the rail lock hole and pull it towards direction ①.
- 2) Remove the unit by pulling the unit towards direction ②.

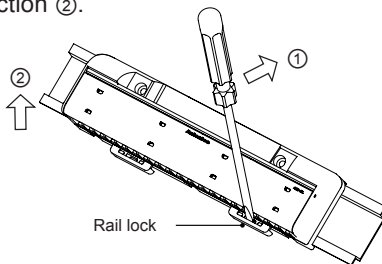

◎ Mounting with screws

- 1) The unit can be mounted on panels using the mounting holes on the side of the unit.
- 2) M3×30mm spring washer screws are recommended for installation. When using flat washers, use Ø6mm diameter washers. The tightening torque should be between 5.1 and 7.14kgf·cm (0.5 to 0.7 N·m).

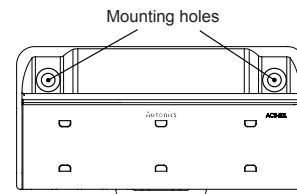

■ Caution During Use

1. Do not use the product outside of rated temperature and humidity.
2. Check to make sure that voltage fluctuation in the power supply is within the rated range.
3. When connecting PLC or other controllers, check the power polarity before wiring.
4. Use AWG 16 (1.25mm²) wire for power and use appropriate crimp connectors for the terminals.
5. Do not connect or disconnect the connector or perform any wiring work while supplied with power.
6. Do not use the unit in the following environments.
 - ① Environments with high vibration or shock.
 - ② Environments where strong alkalis or acids are used.
 - ③ Environments with exposure to direct sunlight.
 - ④ Near machinery which produce strong magnetic force or electric noise
7. This unit may be used in the following environments.
 - ① It shall be used indoor.
 - ② Altitude up to 2,000m
 - ③ Pollution degree 2
 - ④ Installation category II